

ONE GOAL, ONE DREAM - MISSION SELECTION 2024

PREMIUM BUNDLE PDF COURSE 2024

Highlighting Segments

- Beginners Bundle Quiz Course
- Topic-Wise Bundle Course
- Exam-Wise Bundle PDF Course
- Section-Wise Bundle PDF Course
- Memory Based Questions Bundle Course
- Prelims Scoring Part Bundle Course
- Mains Booster Bundle Course
- Critical Reasoning Bundle Course
- Mains Two Mark Questions Bundle Course
- Daily Editorial Based English Questions PDF
- Special Quants Arithmetic Bundle Course
- Special DI & Caselet Bundle Course
- Special Puzzles & Seating Bundle Course
- 101 Version 2.0 New Pattern Puzzles & DI Questions
- Current Affairs Bundle PDF Course
- Static Banking & Static GK Bundle Course
- Computer Awareness Bundle Course

***Special Offer For PRIME Users**

One Time Offer Ends Soon - Hurry!!!

GRAB IT NOW

Parallel Row Seating Arrangement for Bank Exam – Question Bank Set 1 (Eng)

Directions (1-5): Study the following information carefully and answer the below questions.

Twelve persons are seated in the two parallel rows and facing each other. In row 1 O, P, Q, R, S, and T are seated and facing the south direction and in row 2 U, V, W, X, Y, and Z are seated and facing the north direction.

T sits second to the right of O who faces the one who sits third to the right of U. Two persons sit between T and Q who faces the person sits immediate right of Z. As many persons sit to the left of Z is the same as to the left of P. Only one person sits between P and the person who faces V. Y sits third from V. R faces the person sits second to the left of W who sits to the right of X.

1) Who sits third to the left of the person faces R?

- A. The person who faces P
- B. The person who faces Q
- C. The person who faces S
- D. The person who faces T
- E. None of these

2) Who sits exactly between the person who faces S and Z?

- A. The one who sits immediate left of U
- B. The one who sits immediate right of V
- C. The one who sits third to the left of W
- D. The one who sits second to the right of Z
- E. None of these

3) Which of the following statement is/are true with respect to V?

I. Two persons sit between S and the person who faces V

II. P sits second to the right of the person who faces V

III. More than two persons sit between V and Y

- A. Only III
- B. Both I and II
- C. Both I and III
- D. All I, II and III
- E. None of these

4) Four of the following five are alike in a certain way and hence from the group. Which is the one that does not belong to the group?

- A. Q
- B. Y
- C. W
- D. X
- E. S

5) In which of the following statement the person who faces the third person sits exactly between the first and the second person in the following arrangement?

- I. YZT
- II. WUR
- III. PQX
- A. Only I
- B. Only II
- C. Only I and II
- D. All I, II, and III
- E. None of these

Parallel Row Seating Arrangement for Bank Exam – Question Bank Set 1 (Eng)

Directions (6-10): Study the following information carefully and answer the below questions

Ten persons are sitting in two parallel rows and facing each other. In Row 1 A, B, C, D and E are seated and faces south. In row 2 P, Q, R, S, and T are seated and faces north. All the information is not necessarily in the same order.

P sits third to the left of T. Q and T are immediate neighbours. C sits immediate left of E. B sits third to the right of E. The numbers of persons sitting between P and Q is the same as between B and A. Either B or A sits at the end of the row. The numbers of persons sitting to the left of C is the same as to the left of R.

6) Who among the following person faces B?

- A. P
- B. The one who sits second to the left of Q
- C. The one who sits immediate left of P
- D. S
- E. T

7) How many persons are seated to the right of A?

- A. None
- B. One
- C. Two
- D. Four
- E. Three

8) Four of the five among the following are similar in such a way to form a group, which one of the following doesn't belong to the group?

- A. B, P
- B. D, S
- C. A, Q
- D. E, T
- E. C, R

9) If all the persons are made to sit in the alphabetical order from left to right in Row-1, then how many persons remain unchanged in their position?

- A. One
- B. None
- C. Two
- D. Three
- E. Four

10) Who among the following persons are the immediate neighbour of S?

- I) R
- II) Q
- III) T
- A. Both (I) and (II)
- B. Both (II) and (III)
- C. Only (III)
- D. Only (II)
- E. Both (I) and (III)

Parallel Row Seating Arrangement for Bank Exam – Question Bank Set 1 (Eng)

ANSWER WITH EXPLANATION

Directions (1-5):

- 1) Answer: C
- 2) Answer: C
- 3) Answer: B
- 4) Answer: D
- 5) Answer: C

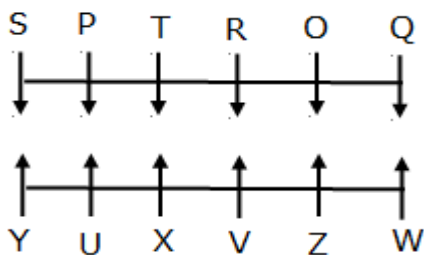

T sits second to the right of O who faces the one who sits third to the right of U. Two persons sit between T and Q who faces the person sits immediate right of Z.

Case I

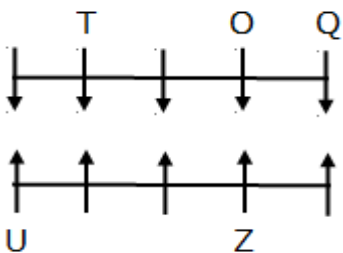

As many persons sit to the left of Z is the same as to the left of P. Only one person sits between P and the person who faces V.

Case I

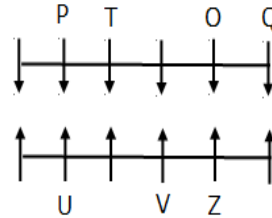

Case II

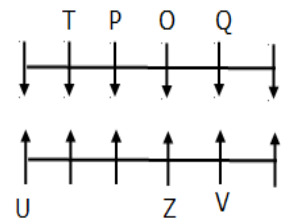

Y sits third from V. R faces the person sits second to the left of W who sits to the right of X.

~~Case II~~

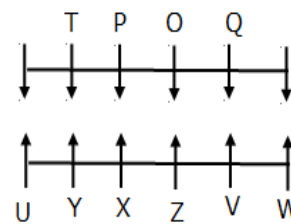

Case I

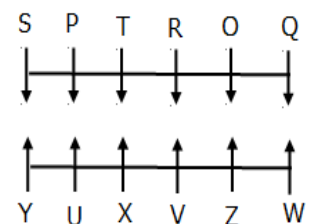

Directions (6-10):

- 6) Answer: C
- 7) Answer: C
- 8) Answer: E
- 9) Answer: A
- 10) Answer: D

Final Arrangement

Parallel Row Seating Arrangement for Bank Exam – Question Bank Set 1 (Eng)

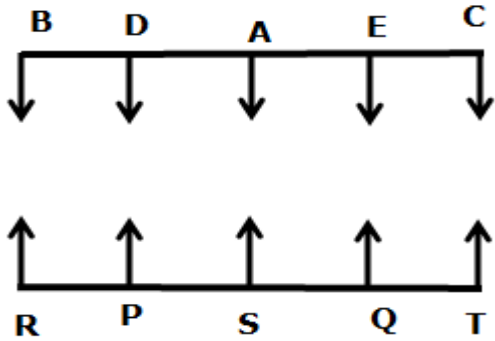

We have,

- P sits third to the left of T.
- Q and T are immediate neighbours.

From the above condition, there are three possibilities.

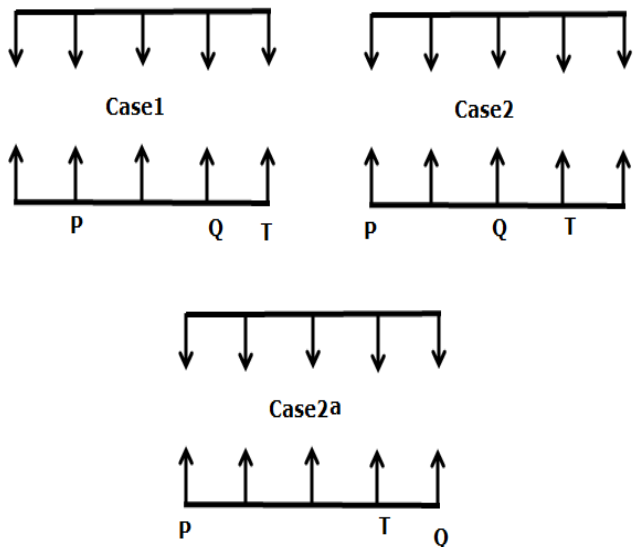

Again we have,

- C sits immediate left of E.
- B sits third to the right of E.

- The number of persons sitting between P and Q is the same as between B and A.
- Either B or A sits at the end of the row.

From the above condition, case-2a get eliminated.

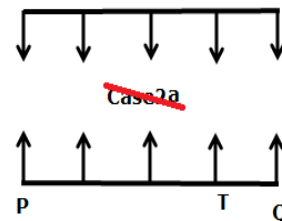
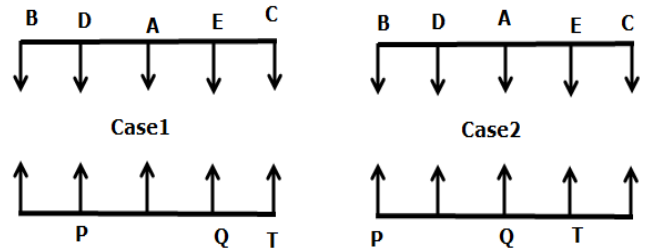

Again we have,

- The numbers of persons sitting to the left of C is the same as to the left of R.

From the above condition, case-2 gets eliminated. Case-1 shows the final arrangement.

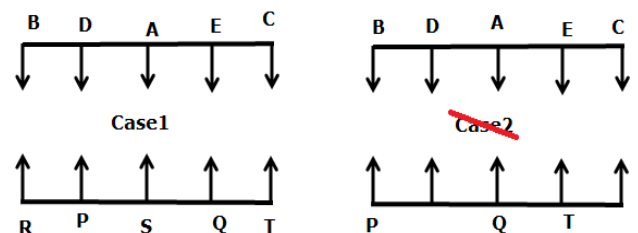

Parallel Row Seating Arrangement for Bank Exam – Question Bank Set 1 (Eng)

[Click Here For Bank Exam Free PDF](#)

[Click Here For Reasoning Free PDF](#)

[Click Here For Quantitative Aptitude Free PDF](#)

[Click Here For English Free PDF](#)